

OPERATION GUIDE MCX-2S

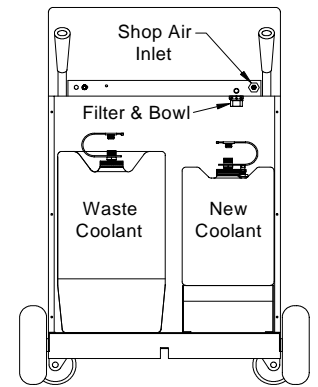

SET UP

1. Remove the new coolant tank cap and fill the tank with new coolant and water in the proportions specified by the coolant supplier.
2. Replace the tank cap. *Make sure the green new coolant hose is securely connected and the plug is removed from the tank cap for venting. Slide the tank to the front so the liquid level can be seen through the front panel slot.*
3. Fasten the clips on the tank strap to secure the tanks.
4. Verify that all three (3) switches are in the off position.

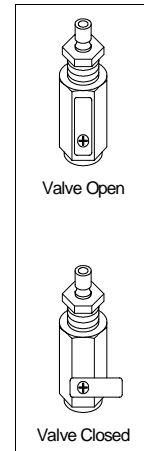
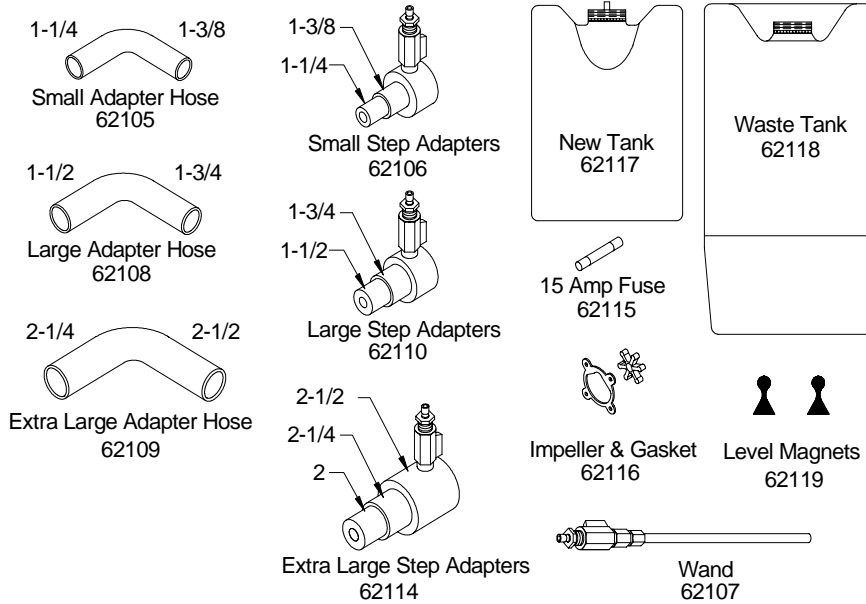
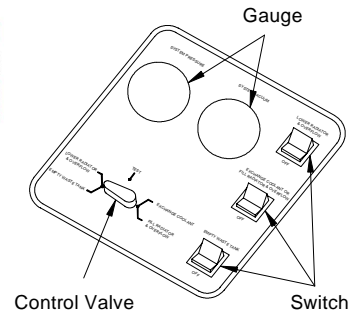

RELIEVE SYSTEM PRESSURE

1. Connect shop air to port on the rear of the unit.
2. Connect small-diameter clear hose from the exchange equipment to the overflow port on the neck under the pressure cap.
3. Relieve system pressure.
4. Disconnect air hose from machine.
5. Disconnect clear hose from overflow port.

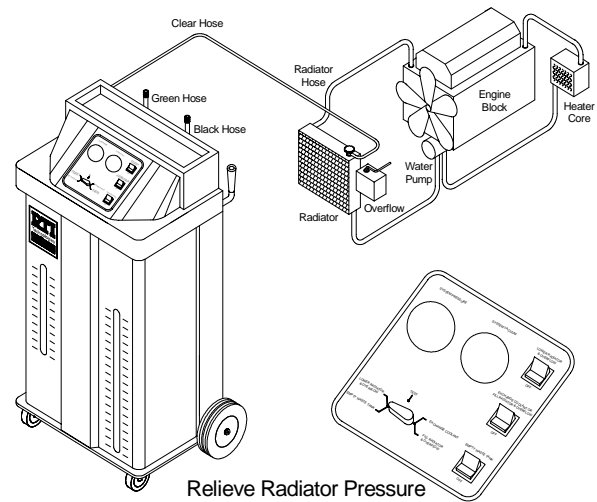

LOWER COOLANT LEVEL

WARNING: PRESSURE CAP MAY BE HOT!

1. Remove cap from the overflow container if equipped.
2. Attach the wand to the black return hose. Close the valve on the wand.
3. Set control valve to "lower radiator & overflow" and then press the red "lower radiator & overflow" switch to the on position.
4. Insert wand into overflow container and empty.
5. Insert wand into radiator and remove coolant level below the upper radiator hose.
6. Press the red "lower radiator & overflow" switch to the off position.
7. Replace caps on the radiator and overflow container.

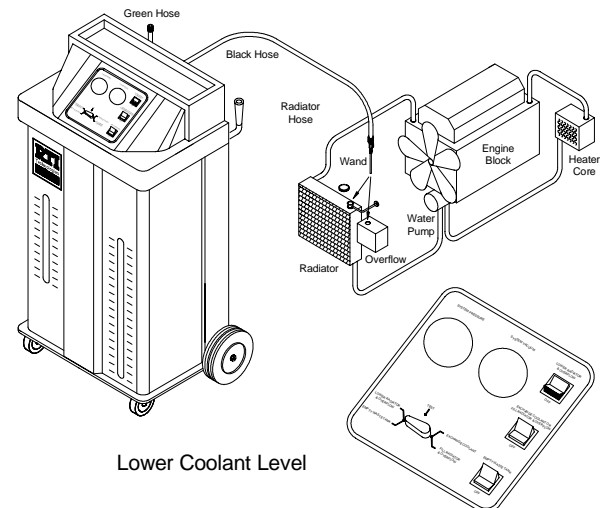

EXCHANGE COOLANT

1. Disconnect the upper radiator hose from the engine.
2. Install a hose adapter and step adapter to the engine (Figure A).
3. Install a gray step adaptor to the upper radiator hose.
4. Connect the green new coolant hose to the hose leading to the engine.
5. Connect the black return hose to the step adapter leading to the coolant return. Some cars will require a special hook up.
6. Open the valves on the step adapters.
7. Check the tank levels, the minimum fill on the new coolant tank is the vehicle's capacity. The waste tank should be able to accept the vehicle's capacity.
8. Set coolant level markers to the correct level on the new coolant gauge.
9. Turn control valve to "exchange coolant" and press the red "exchange coolant or fill radiator & overflow" switch to the on position.

If coolant levels don't start to change in five seconds, press off the "exchange coolant or fill radiator & overflow" selector switch.

TEST COOLANT SYSTEM FOR LEAKS

1. Turn control valve to "test" and press on the "exchange coolant or fill radiator & overflow" selector switch (Figure B). Machine will shut off at 10 -15 PSI.
2. Inspect for leaks. Red switch off.
3. Monitor for constant pressure to verify system integrity.

COMPLETE THE JOB

1. Turn the control valve to "lower radiator & overflow", press the red "lower radiator & overflow" switch to the on position and wait until pressure reads "0".
2. Press the red "lower radiator and overflow" switch to the off position.
3. Remove the pressure cap.
4. Close wand valve and step adapter. Install the wand on the black waste coolant hose.
5. Press the red "lower radiator & overflow" switch to the on position.
6. Open the valve on the wand to lower the coolant level in the radiator to a level just below the upper hose (Figure C).
7. Press the red "lower radiator & overflow" switch to the off position. Remove the adaptor hose and the step adaptors.
8. Reattach the radiator hose.
9. Install the wand on the green new coolant hose. Close valve.
10. Turn the control valve to "fill radiator & overflow" and press the red "exchange coolant or fill radiator & overflow" switch to the on position.
11. Open the valve on the wand to fill the radiator to the maximum level and the coolant overflow to the adjusted level of slightly above the MAX or hot line (Figure D).
12. Press the red "exchange coolant or fill radiator & overflow" switch to the off position. Install pressure cap and recovery tank cap if equipped.
13. Wipe off excess coolant on or around the area.

TECHNICAL SUPPORT: 800-468-2321

Mon. - Fri. 8AM - 5PM and Sat. - Sun. 8AM - 12PM (Eastern Time)

A

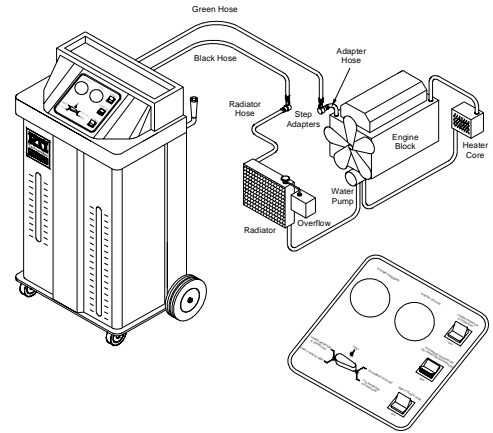

B

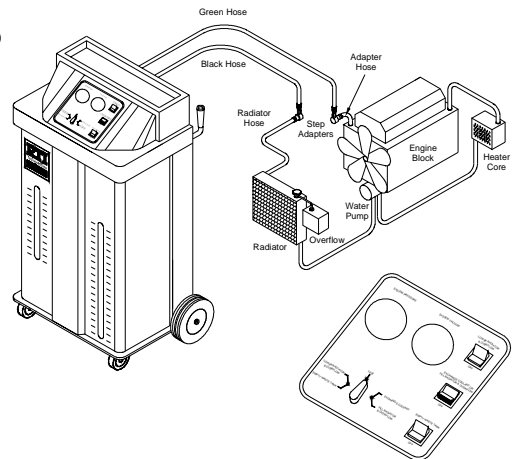

C

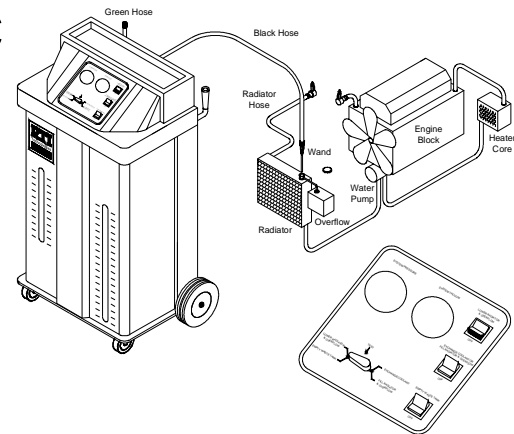

D

