

OPERATION & MAINTENANCE MANUAL

RHS730E

Refrigerant Handling Station



RTI Technologies, Inc.

4075 East Market Street

P.O. Box 3099

York, Pennsylvania USA 17402

717-840-0678 (Ext. 259)

Web: www.rtitech.com

E-mail: tech@rtitech.com

Manual P/N 035-81131-00

Two Modes of Operation

The RHS730E can be used to perform semi-automatic procedures or run in a fully automatic mode.

The following Table of Contents will direct you to the proper sections for detailed operating instructions.

TABLE OF CONTENTS - RHS730E

Before Using the RHS730E	2
Safety Precautions	2
How the RHS730E Operates	3
Setup	4
Semi-Automatic Procedures	
Fill Charge Cylinder	5
Recycle	6
Drain Recovered Oil	7
Manual Air Purge	7
Deep Vacuum	8
Charge	9
Fully Automatic Procedure	
Automatic	10
Programming & Maintenance	
Access Stored Data	13
Set Over Charge Amount	14
Calibrate Weight Scale	15
Scheduled Maintenance	16
Filter Maintenance	16
Change Filters	16
Parts Identification	17
Solenoid, Pressure Switch & Contactor Identification ..	19

BEFORE USING THE RHS730E

Check for any shipping damage. Place a claim with carrier if damage is discovered. **DO NOT USE A DAMAGED UNIT.**

These general instructions describe normal operation and maintenance situations encountered with the RHS730E. Failure to read and comply with these instructions or any one of the limitations noted herein can result in serious injury and/or property damage.

A few minutes spent reading these instructions can make an operator aware of dangerous practices to avoid and precautions to take for his own safety and the safety of others. The instructions should not be interpreted to anticipate every possible contingency.

The RHS730E should not be operated or serviced by any person who has not read all the contents of this manual.

It is the responsibility of the owner/user to operate the RHS730E in accordance with all specifications and laws which may apply.

A regular schedule of inspection of the RHS730E should be established and records maintained with special attention given to Hoses and Filters.

SAFETY PRECAUTIONS

Recycle and Charge only the refrigerant for which the machine is configured.

Wear safety glasses and protective gloves. Refrigerant has a very low boiling point and can cause frostbite.

Follow the RHS730E operating procedures sequentially to avoid prematurely disconnecting hoses or opening valves which may release refrigerant to the atmosphere.

Do not expose the RHS730E to moisture or operate in wet areas.

Use the RHS730E in locations with mechanical ventilation that provides at least four air changes per hour.

Hoses used with the RHS730E must have shutoff devices within 12 inches (30 centimeters) of the connection point to the A/C System to minimize the introduction of Non-Condensable Gas (Air) into the RHS730E and the release of refrigerant when being connected or disconnected.

Disconnect power before performing any maintenance or service on the RHS730E.

Connect the RHS730E to a properly grounded receptacle. Do not over load the circuit.

Avoid using an extension cord with the RHS730E. If necessary, use a good condition three wire, grounded, #14 AWG (2.0 mm²) or larger extension cord of the shortest possible length (maximum 25 ft. - 8 m).

Do not connect the RHS730E to the liquid side of any A/C System with a capacity greater than 4 lbs (1.8 Kg.) Refrigerant in A/C Systems having larger capacities must be recycled from the vapor side only.

Never connect the Red or Blue Hose of the RHS730E to the Liquid Port of a Cylinder of Refrigerant to fill the Charge Cylinder. Doing so may cause the Compressor to fail and void the warranty.

Avoid breathing refrigerant or lubricant vapor or mist. Exposure may irritate eyes, nose and throat. If accidental system discharge occurs, ventilate work area before continuing.

Additional health and safety information may be obtained from refrigerant and lubricant manufacturers.

SPECIAL CONSIDERATIONS WITH R134a

R134a has been shown to be nonflammable at ambient temperature and atmospheric pressure. However, tests under controlled conditions have indicated that at pressures above atmospheric and with air concentrations greater than 60 percent by volume, R134a can form combustible mixtures.

While it is recognized that an ignition source is also required for combustion to occur, the presence of combustible mixtures is a potentially dangerous situation and should be avoided.

Under no circumstances should any equipment be pressure tested or leak tested with air and R134a mixtures. Do not use compressed air (shop air) for leak detection in R134a systems.

HOW THE RHS730E OPERATES

The RHS730E is microprocessor controlled with a menu-driven user interface. All functions are performed by entering a few simple key strokes and following the prompts on the display. The on-board charge cylinder is mounted on a load cell. The weight of refrigerant in the charge cylinder is electronically displayed.

The RHS730E has a Fill Cylinder feature which allows refrigerant to be transferred directly into the charge cylinder without going through the normal Recycle mode. This feature allows the RHS730E charge cylinder to be re-filled directly from a cylinder of new refrigerant. The process automatically stops at approximately 20 lbs (9 kg).

The RHS730E recycles refrigerant in a true single-pass through the filters and stores the refrigerant in the charge cylinder where it's immediately available for use. This process automatically stops at 24 lbs (11 Kg) or when a 15 In-Hg (-0.5 Bar) vacuum is sensed in the A/C system.

The RHS730E pauses for a minimum factory-set default of two minutes for out gassing and cold refrigerant to raise the pressure back up to 3 psig (0.2 Bar) at which time the recycle process will start again and reset the Recycle Hold Timer. When the pressure does not rise to reset the timer during the two minute pause, the display will indicate that the process is complete. The Recycle Hold Timer can be changed every time a Recycle procedure is run.

Longer recycle hold times should be selected on colder days or when servicing an A/C system with a large liquid capacity. Increasing this value may increase total time to recycle while decreasing the time may result in an incomplete recycling of refrigerant from the A/C system.

Refer to the table below for guidelines on setting the Recycle Hold Timer. The value entered is stored in the memory of the RHS730E and becomes the default value each time it is set.

Temperature	Less than 50° F (10° C)	50° F (10° C) to 80° F (26.5° C)	Greater than 80° F (26.5° C)
Recycle Hold Time	10 minutes	5 minutes	2 minutes

Non-condensable gases (air) are vented automatically during the recycle process.

The amount of refrigerant recycled is displayed at the end of the procedure. This value is added to the total amount recycled and is stored in the memory of the RHS730E.

The double duty compressor draws on both the high and low hoses, ensuring complete evacuation of the A/C system. The amount of time that the vacuum procedure has been programmed to run will count down on the display. The value entered is stored in the memory of the RHS730E and becomes the default value each time it is set.

The low pressure gauge can be monitored to see a rise in A/C system pressure. When programmed to do so, the RHS730E will pause and start a count up timer indicating how long the vacuum process has been off, thus allowing the operator to determine if a vacuum leak is present based on increasing pressure over time. A rapid rise in pressure indicates the presence of a large leak that should be repaired. A slow rise in pressure may simply indicate that a longer recycle hold time or vacuum time value should have been entered.

A relatively constant vacuum reading over a long period of time (less than 2 In-Hg [0.05 Bar] rise over ten minutes) is the most accurate way to check for vacuum leaks.

The RHS730E can also be programmed to pause to allow oil to be added to the A/C system after vacuuming and prior to charging.

Charging is done from the on board charge cylinder. An integrated heater automatically engages whenever charging occurs. The A/C capacity is entered on the Keypad. The value entered is stored in the memory of the RHS730E and becomes the default value each time it is set. As refrigerant leaves the RHS730E, the display will show an increasing weight up to the programmed charge amount plus a factory-set one ounce (0.03 Kg) over charge amount necessary for compensation of refrigerant loss in the hoses.

The over charge amount can be changed to accommodate different operating conditions. The amount of refrigerant charged is added to the total amount charged and stored in the memory of the RHS730E.

The low side blue hose can be connected to the high side port of the RHS730E for charging to the low side of vehicles with only a low side port. Follow the vehicle manufacturer's charging procedure when charging to the low side to avoid damaging the A/C system compressor.

SETUP

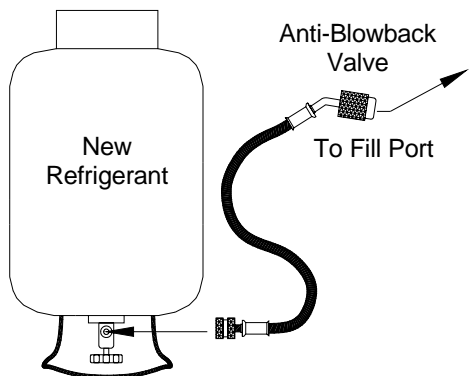
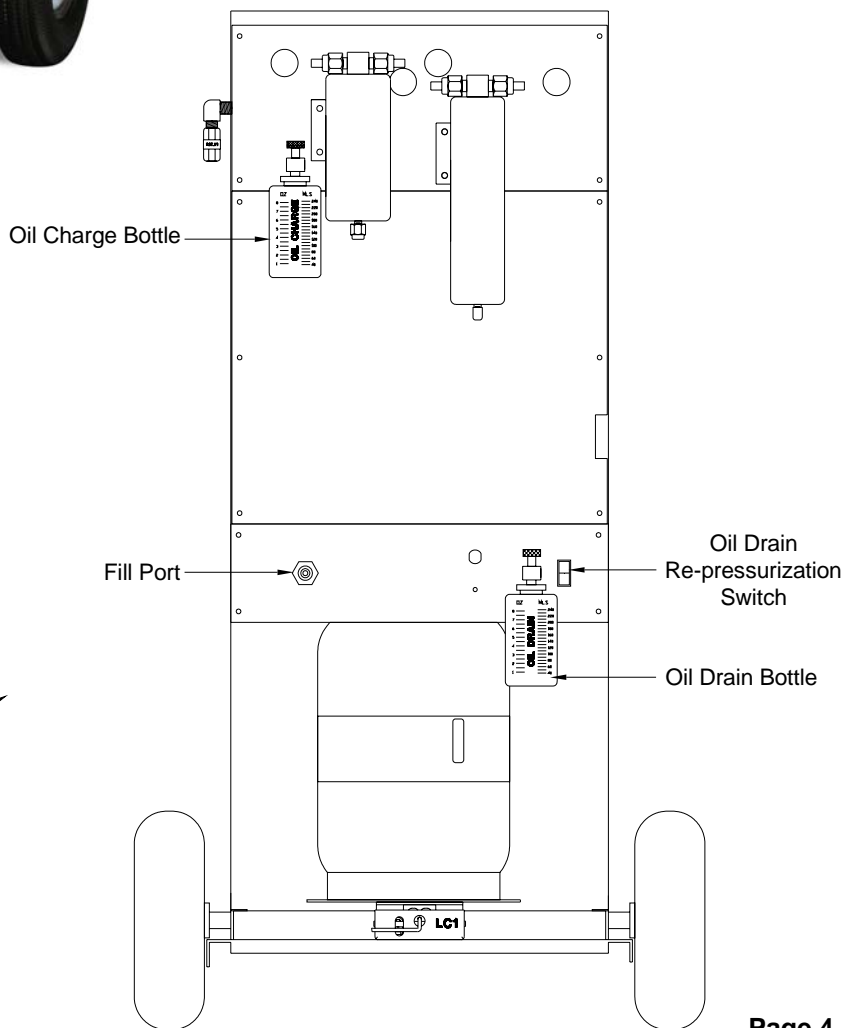

WEIGHT = XX.X LB
AUTOMATIC? ←

▲▲▲▲

WEIGHT = XX.X LB
FILL CYLINDER? ←

ENTER

START? ←

ENTER

WEIGHT = XX.X LB
COMPRESSOR ON

FILL COMPLETE
FILLED = XX.X LB ←

ENTER

*

HIGH PRESSURE
SEE MANUAL

**

CYLINDER FULL
GO TO CHARGE ←

FILL CHARGE CYLINDER

1. Connect a cylinder of new refrigerant to the Fill Port on the rear of the RHS730E as shown on Page 4. **Anti-blowback Valve must connect to the RHS730E.** Turn the cylinder up-side-down. Turn Main Power Switch on.

The display will show **WEIGHT= XX.X LB AUTOMATIC? ←.**

2. Press the ▲ key four times to display **WEIGHT= XX.X LB FILL CYLINDER? ←.**
3. Press the ENTER key. The display will read **START? ←.**
4. Open the valve on the cylinder of new refrigerant.
5. Press the ENTER key to start filling the RHS730E.

The Display will read **WEIGHT= XX.X LB COMPRESSOR ON.** When the weight is approximately 20 lbs (9 kg) the RHS730E will turn OFF, the display will read **FILL COMPLETE FILLED=XX.X LB ←** (the amount of refrigerant removed from the cylinder). The Attention Light will turn on.

The RESET button on the keypad can be pressed at any time to stop the Fill Cylinder procedure prior to it filling and shutting off automatically.

6. Close the valve on the refrigerant cylinder.
7. Press the ENTER key to return to the Main Menu.

This procedure may be slow or fail to work if the internal charge cylinder pressure is higher than the pressure in the cylinder of new refrigerant. Check and purge air if necessary (See Page 7).

Also, try putting a heat belt on the new refrigerant cylinder.

- * While filling the charge cylinder, this screen will display periodically concurrent with the Attention Light turning on. This is normal and nothing to be concerned about. The screen will return to normal after a few seconds.

- ** This screen will display if the charge cylinder fills to capacity, approximately 24 lbs (11 Kg). If this occurs, the weight can be lowered using the Charge procedure on Page 9. This must be done before the RHS730E can be used to recycle more refrigerant. Press the ENTER key to return to the Main Menu.

Notes:

It may be desirable to skip this procedure for large capacity or multiple A/C systems where recharge will not be done between successive recycling procedures.

The RHS730E uses 22 lbs (10 Kg) of refrigerant when filling the first time. If the cylinder of new refrigerant is emptied, the RHS730E will appear to stop filling (the weight displayed will stop increasing) and will stay in this condition until the RESET key is pressed.

The RHS730E will use 1.1 Lb (0.5 Kg) more refrigerant than the displayed value the very first time it is used or after performing a Calibration Procedure in order to prime the internal components.

The RHS730E Charge Cylinder can also be filled from the GAS or VAPOR side of a cylinder by following the Recycle procedure on Page 6.

The yellow hose can be disconnected from the Fill Port on the rear of the RHS730E and reconnected to either the Blue (Low side) or Red (High Side) hose connection port on the side of the RHS730E to allow recycling any refrigerant remaining in the yellow hose using the Recycle procedure on Page 6.

RECYCLE

WEIGHT = XX.X LB
AUTOMATIC? ←

▲

WEIGHT = XX.X LB
RECYCLE? ←

ENTER

RECYCLE HOLD
TIME XX MIN ←

▲► ENTER

START? ←

ENTER

WEIGHT = XX.X LB
COMPRESSOR ON

WEIGHT = XX.X LB
COMPRESSOR OFF

AMOUNT RECYCLED =
XX.X LB ←

ENTER

DRAIN RECOVERED
OIL NOW! ←

ENTER

*
HIGH PRESSURE
SEE MANUAL

**

CYLINDER FULL
GO TO CHARGE ←

1. See RHS730E Setup on Page 4. Turn Main Power Switch on.

The display will show **WEIGHT= XX.X LB AUTOMATIC? ←**

2. Attach Red and Blue Hoses to the A/C System per the vehicle manufacturer's instructions. Open the Red and Blue Hose Valves.

3. Press the ▲ key one time to display **WEIGHT= XX.X LB RECYCLE? ←** and press the ENTER key. The Display will read **RECYCLE HOLD TIME XX MIN ←**.

The Recycle Hold Time is the amount of time that the RHS730E waits for out-gassing or for the pressure in the A/C System being recycled to rise enough to automatically restart the recycling process. The minimum time is two minutes. The value entered is stored in the memory of the RHS730E and is displayed as the default value next time.

4. Press the ▲ key to change the value of the field. Press the ► key to move to a different field. Press the ENTER key to accept the value. The Display will then read **START? ←**.

5. Press the ENTER key to start recycling.

The Display will read **WEIGHT= XX.X LB COMPRESSOR ON**. The RHS730E will recycle refrigerant from the A/C system and automatically cycle OFF when a vacuum is sensed. This vacuum level can be seen on the Low Pressure Gauge. The Display will read **WEIGHT= XX.X LB COMPRESSOR OFF**.

A small quantity of refrigerant will probably remain in the A/C system as observed by an increasing pressure on the Low Pressure Gauge. The RHS730E will automatically cycle on to continue recycling refrigerant if pressure rises to a preset level. This automatic cycling will repeat, resetting the Recycle Hold Timer each time. When the RHS730E remains off for the duration of the Recycle Hold Timer value entered in Step 4, the Display will read **AMOUNT RECYCLED= XX.X LB ←** and the Attention Light will turn on.

6. Close the Red and Blue Hose Valves and disconnect the hoses from the A/C system.

7. Press the ENTER key. The Display will read **DRAIN RECOVERED OIL NOW! ←**. Drain any recovered oil using the Drain Recovered Oil procedure on Page 7.

8. Press the ENTER key to return to the Main Menu.

* This screen will display if there is an internal fault. Turn the RHS730E Main Power Switch off. Contact RTI Technical Support.

** This screen will display if the charge cylinder fills to capacity of approximately 24 lbs (11 Kg.). If this occurs, the weight must be lowered using the Charge procedure on Page 9 before the RHS730E can be used to recycle more refrigerant. Press the ENTER key to return to the Main Menu.

DRAIN RECOVERED OIL

Oil is separated from the recycled refrigerant and **MUST** be removed following **EACH** Recycle procedure to determine the amount (if any) required to add into the A/C system as follows:

1. Turn Main Power Switch on. The display will show **WEIGHT= XX.X LB AUTOMATIC? ←**.
2. Press and hold the Oil Drain Re-pressurization Switch on the rear of the RHS730E for five seconds.
3. **Slowly** open the valve on the Oil Drain Bottle to drain any oil which may have been removed from the A/C System.
Unless the A/C System had previously been overfilled, the RHS730E will typically not remove enough oil to make replenishment necessary.
4. Close the valve on the Oil Drain Bottle.
5. Press and hold the Oil Drain Re-pressurization Switch for five seconds. This allows any residual Non-Condensable Gas to be re-circulated for reprocessing during the next recycle procedure.

WARNING

Failure to perform the Drain Oil procedure after every recycle procedure will cause the RHS730E to eventually fail.

Repair of the RHS730E to correct this problem is not covered by warranty.

Manual Air Purge

The RHS730E purges air (also referred to as Non-Condensable Gas) automatically. There may be occasions where an extra purge may be desired. One instance is when the Fill Charge Cylinder process seems slow. The following steps allow a manual purge.

1. Turn Main Power Switch on. The display will show **WEIGHT= XX.X LB AUTOMATIC? ←**.
2. **Slowly** open the valve on the Oil Drain Bottle.
3. Press and hold the Oil Drain Re-pressurization Switch on the rear of the RHS730E for five seconds.
4. Close valve on the Oil Drain Bottle.
5. Press and hold the Oil Drain Re-pressurization Switch for five seconds.

DEEP VACUUM

```
WEIGHT =   XX.X LB
AUTOMATIC? ←
```

▲▲

```
WEIGHT =   XX.X LB
VACUUM? ←
```

ENTER

*

```
A/C HAS PRESSURE
GO TO RECYCLE ←
```

```
ENTER VACUUM
TIME XX MIN ←
```

▲► ENTER

```
PERFORM LEAK
TEST? Y/N ←
```

► ENTER

```
ADD OIL? Y/N ←
```

► ENTER

```
START? ←
```

ENTER

```
TIME LEFT = XX MIN
PUMP ON
```

```
PUMP OFF XX MIN
CONTINUE? ←
```

ENTER

```
ADD OIL NOW
CONTINUE? ←
```

ENTER

1. See RHS730E Setup on Page 4. Turn Main Power Switch on.
2. Attach Red and Blue Hoses to the A/C System per the vehicle manufacturer's instructions. Open the Red and Blue Hose Valves.
3. Press the ▲ key two times to display **WEIGHT= XX.X LB VACUUM?** ← and press the ENTER key. The Display will read **ENTER VACUUM TIME XX MIN** ←.

* This screen will display if the RHS730E senses a pressure in either the Red or Blue Hose. When this occurs, the A/C System must be emptied using the Recycle procedure on Page 6. Press the ENTER key to return to the Main Menu.

4. Press the ▲ key to change the value of the field. Press the ► key to move to a different field. The value entered must be greater than zero. Press the ENTER key to accept the value. The Display will read **PERFORM LEAK TEST? Y/N** ←.
5. Press the ► key to move the cursor between Y and N to select whether or not the RHS730E pauses at the end of Vacuum procedure so that a vacuum leak can be detected in the A/C system. Press the ENTER key to accept the Yes or No choice. The value entered is stored in the memory of the RHS730E and is displayed as the default value next time. The Display will read **ADD OIL? Y/N** ←.
6. Press the ► key to move the cursor between Y and N to select whether or not the RHS730E pauses at the end of the Vacuum procedure (or Leak Test) to allow adding of oil to the A/C system. Press the ENTER key to accept the Yes or No choice. The value entered is stored in the memory of the RHS730E and is displayed as the default value next time. The Display will read **START?** ←.
7. Press the ENTER key to start the Vacuum procedure.

The vacuum procedure will begin, the display will read **TIME LEFT=XX MIN PUMP ON**. The minutes remaining will count down on the display. The vacuum process will end when the display reads zero minutes.

8. If a Vacuum Leak Check was selected by choosing Y in Step 5 the display will read **PUMP OFF XX MIN CONTINUE?** ← and the Attention Light will turn on. The elapsed time since the Vacuum process turned off will count up on the display. An increasing pressure on the Low Pressure Gauge is evidence of a vacuum leak in the A/C system. Press the RESET key to return to the Main Menu (so the leak can be repaired) or press the ENTER key to proceed to Add Oil if selected in Step 6.
9. If Add Oil was selected by choosing Y in Step 6 the Display will read **ADD OIL NOW CONTINUE?** ←. The Attention Light will turn on.

Fill the Oil Charge Bottle. Open the valve on the Oil Charge Bottle and leave it open until the correct amount of oil has left the Oil Charge Bottle. Close the valve on the Oil Charge Bottle and press the ENTER key to return to the Main Menu. (The oil drawn in will be charged with the refrigerant during the Charge procedure on Page 9).

WEIGHT = XX.X LB
AUTOMATIC? ←

▲▲▲

WEIGHT = XX.X LB
CHARGE? ←

ENTER

ENTER CHARGE
AMOUNT = XX.X LB ←

▲► ENTER

*

LOW LEVEL, GO TO
FILL CYLINDER ←

CHECK HOSES ←

ENTER

WEIGHT = XX.X LB
CHARGING

CHARGE COMPLETE
EVAC HOSES ←

ENTER

CHARGE

1. See RHS730E Setup on Page 4. Turn the Main Power Switch on.
2. Attach the Red and Blue Hoses to the A/C system per the vehicle manufacturer's instructions and open the Red and Blue Hose Valves.
3. Determine the refrigerant capacity of the A/C system to be charged.

1 oz = 0.02835 Kg 1 Lb = 0.45359 Kg

4. Press the ▲ key three times to display **WEIGHT= XX.X LB CHARGE?** ← and press the ENTER key. The Display will read **ENTER CHARGE AMOUNT= XX.X LB** ←.
5. Press the ▲ key to change the value of the field. Press the ► key to move to a different field. The value entered must be greater than zero. Press the ENTER key to accept the value. The value entered is stored in the memory of the RHS730E and is displayed as the default value next time. The Display will read **CHECK HOSES** ←.

- * This screen will display if the RHS730E charge cylinder contains less refrigerant than the entered value. When this occurs, the charge cylinder should be filled using the Fill Cylinder procedure on Page 5. Press the ENTER key to return to the Main Menu.

Refrigerant is usually charged to the high side of an A/C system through the Red Hose. The Blue Hose can be connected to the high side port (where Red Hose is normally connected) if it is desired to charge to the low side of the A/C system. This should only be done if the vehicle manufacturer specifies charging to the low side.

Do not turn on the A/C system.

SAE compliant refrigerant handling stations, like the RHS730E, charge refrigerant in the liquid phase. Adding liquid refrigerant to a running A/C system may cause immediate A/C compressor failure.

6. Press the ENTER key to start charging.

The Display will read **WEIGHT= XX.X LB CHARGING** as refrigerant leaves the Charge Cylinder. The weight displayed will increase from zero to the charge amount entered in Step 5 plus a one ounce (0.03 Kg) over charge set at the factory to compensate for refrigerant left in the hoses (See Set Over Charge Amount on Page 14 to change the default value). When the RHS730E has finished, the Display will read **CHARGE COMPLETE EVAC HOSES** ← and the Attention Light will turn on.

7. Press the ENTER key to return to the Main Menu. The A/C system can now be turned on and tested by monitoring the High and Low Pressure Gauges.
8. Close the Red and Blue Hose Valves. Disconnect hoses from the A/C system and go to Page 6 (Recycle) to evacuate the refrigerant from the hoses.

WEIGHT = XX.X LB
AUTOMATIC? ←

ENTER

RECYCLE HOLD
TIME XX MIN ←

▲▶ ENTER

ENTER VACUUM
TIME XX MIN ←

▲▶ ENTER

PERFORM LEAK
TEST? Y/N ←

▶ ENTER

ADD OIL? Y/N ←

▶ ENTER

ENTER CHARGE
AMOUNT = XX.X LB ←

▲▶ ENTER

*
LOW LEVEL, GO TO
FILL CYLINDER ←

ENTER

CHECK HOSES ←

ENTER

START? ←

ENTER

1. See RHS730E Setup on Page 4. Turn Main Power Switch ON.
2. Attach the Red and Blue Hoses to the A/C System per the vehicle manufacturer's instructions and open the Red and Blue Hose Valves.
3. Determine the refrigerant capacity of the A/C System to be charged.

1 oz = 0.02835 Kg 1 Lb = 0.45359 Kg

4. Press the ENTER key when the Display reads **WEIGHT= XX.X LB AUTOMATIC?** ←. The Display will read **RECYCLE HOLD TIME XX MIN** ←.

The Recycle Hold Time is the length of time that the RHS730E waits for out-gassing or for the pressure in the A/C system being recycled to rise enough to automatically restart the recycling process. The minimum value is two minutes. The value entered is stored in the memory of the RHS730E and is displayed as the default value next time.

5. Press the ▲ key to change the value of the field. Press the ▶ key to move to a different field. Press the ENTER key to accept the value. The Display will read **ENTER VACUUM TIME XX MIN** ←.

6. Press the ▲ key to change the value of the field. Press the ▶ key to move to a different field. Press the ENTER key to accept the value. The Display will read **PERFORM LEAK TEST? Y/N** ←.

7. Press the ▶ key to move the cursor between Y and N to select whether or not the RHS730E pauses at the end of Vacuuming so that a vacuum leak can be detected in the A/C system. Press the ENTER key to accept the Yes or No choice. The value entered is stored in the memory of the RHS730E and is displayed as the default value next time. The Display will read **ADD OIL? Y/N** ←.

8. Press the ▶ key to move the cursor between Y and N to select whether or not the RHS730E pauses at the end of Vacuum procedure (or Vacuum Leak Test) to allow the adding of oil to the A/C system. Press the ENTER key to accept the Yes or No choice. The value entered is stored in the memory of the RHS730E and is displayed as the default value next time. The Display will read **ENTER CHARGE AMOUNT= XX.X LB** ←.

9. Press the ▲ key to change the value of the field. Press the ▶ key to move to a different field. The value entered must be greater than zero. Press the ENTER key to accept the value. The value entered is stored in the memory of the RHS730E and is displayed as the default value next time. The Display will read **CHECK HOSES** ←.

* This screen will display if the RHS730E charge cylinder contains less refrigerant than the entered value. When this occurs, the charge cylinder should be filled using the Fill Cylinder procedure on Page 5. Press the ENTER key to return to the Main Menu.

10. Press the ENTER key. The Display will read **START?** ←.

Do not turn on the A/C system

SAE compliant refrigerant handling stations, like the RHS730E, charge refrigerant in the liquid phase. Adding liquid refrigerant to a running A/C System may cause immediate A/C compressor failure.

11. Press the ENTER key to start the RHS730E Automatic sequence.

AUTOMATIC

WEIGHT = XX.X LB
COMPRESSOR ON

WEIGHT = XX.X LB
COMPRESSOR OFF

*
HIGH PRESSURE
SEE MANUAL

**
CYLINDER FULL
GO TO CHARGE ←

TIME LEFT = XX MIN
PUMP ON

PUMP OFF XX MIN
CONTINUE? ←

ENTER

AUTOMATIC - Continued

The Display will read **WEIGHT= XX.X LB COMPRESSOR ON**. The RHS730E will recycle refrigerant from the A/C system and automatically cycle off when a vacuum is sensed. This vacuum level can be seen on the Low Pressure Gauge. The Display will read **WEIGHT= XX.X LB COMPRESSOR OFF**.

* This screen will display if there is an internal fault. Turn the RHS730E Power Switch off. Contact RTI Technical Support.

** This screen will display when the charge cylinder fills to capacity, approximately 24 lbs (11 Kg.) If this occurs, the weight can be lowered using the Charge procedure on Page 9 before the RHS730E can be used to recycle more refrigerant. Press the ENTER key to return to the Main Menu.

A small quantity of refrigerant will probably remain in the A/C system as observed by an increasing pressure on the Low Pressure Gauge. The RHS730E will automatically cycle on to continue recycling refrigerant if pressure rises to a preset level. This automatic cycling will repeat, resetting the Recycle Hold Timer each time.

When the RHS730E remains off for the duration of the Recycle Hold Timer value entered in Step 5 the Display will change to one of the following two steps:

- 1 - The value entered for vacuum time in Step 6 was zero - the Display will read **WEIGHT= XX.X LB CHARGING**. Go to Step 15.
- 2 - The value entered for vacuum time in Step 6 was greater than zero - the Display will read **TIME LEFT=XX MIN PUMP ON**. Go to Step 12.

12 The vacuum procedure will start. The Display will read **TIME LEFT=XX MIN PUMP ON** and the minutes remaining will count down on the Display.

The vacuum procedure will end when the Display reads zero minutes.

13. If a Vacuum Leak Check was selected by choosing Y in Step 7 the Display will read **PUMP OFF XX MIN CONTINUE?** ← and the Attention Light will turn on. (Skip to Step 14 if Vacuum Leak Check was not selected).

The elapsed time since the Vacuum process stopped will count up on the Display. An increasing pressure on the Low Pressure Gauge indicates a vacuum leak in the A/C system. Press the ENTER key to continue with the Automatic sequence or RESET to return to the Main Menu in case of a vacuum leak.

Once the Vacuum Leak Check is complete, any recovered oil must be drained and measured as follows:

- 13.1 Press and hold the Oil Drain Re-pressurization Switch on the rear of the RHS730 for five seconds.
- 13.2 Slowly open the valve on the Oil Drain Bottle to drain any oil which may have been removed from the A/C System.
- 13.3 Close the valve on the Oil Drain Bottle.
- 13.4 Press and hold the Oil Drain Re-pressurization Switch for five seconds. This causes any residual Non-Condensable Gas to be re-circulated for reprocessing during the next recycle procedure.

ENTER

A D D O I L N O W
C O N T I N U E ? ←

ENTER

W E I G H T = X X . X L B
C H A R G I N G

R E C Y C L E D = X X . X L B
E V A C H O S E S ←

ENTER

D R A I N R E C O V E R E D
O I L N O W ! ←

ENTER

AUTOMATIC - Continued

14. If Add Oil was selected by choosing Y in Step 8 the Display will read **ADD OIL NOW CONTINUE?** ← and the Attention Light will turn on. (Skip to Step 15 if Add Oil was not selected).

Fill the Oil Charge Bottle. Open the valve on the Oil Charge Bottle and leave it open until the correct amount of oil (measured in Step 12) has left the Oil Charge Bottle. Close the valve on the Oil Charge Bottle and press the ENTER key to continue. The oil drawn in will be charged with the refrigerant during the Charge procedure.

15. If a Charge Amount greater than zero pounds was entered in Step 9 the Display will read **WEIGHT= XX.X LB CHARGING** as refrigerant leaves the Charge Cylinder. The weight displayed will increase from zero to the Charge Amount entered plus a one ounce (0.03 KG) over charge set at the factory to compensate for hose loss. See Set Over Charge Amount on Page 14 to change the default value. When the RHS730E has finished, the Display will read **RECYCLED=XX.X LB EVAC HOSES** and the Attention Light will turn on.

16. Press the ENTER key. The Display will read **DRAIN RECOVERED OIL NOW!** This is a reminder that **oil must be drained after every recycle procedure**. Drain any recovered oil as follows:

- 16.1 Press and hold the Oil Drain Re-pressurization Switch on the rear of the RHS730E for five seconds.
- 16.2 Slowly open the valve on the Oil Drain Bottle to drain any oil which may have been removed from the A/C System.
- 16.3 Close the valve on the Oil Drain Bottle.
- 16.4 Press and hold the Oil Drain Re-pressurization Switch for five seconds. This causes any residual Non-Condensable Gas to be re-circulated for reprocessing during the next recycle procedure.

WARNING

Failure to perform the Drain Oil procedure after every recycle procedure will cause the RHS730E to eventually fail.

Repair of the RHS730E to correct this problem is not covered by warranty.

17. Press the ENTER key to return to the Main Menu. The A/C System can now be turned on and checked by monitoring the High and Low Pressure Gauges.
18. Close the Red and Blue Hose Valves. Disconnect them from the A/C System and go to Page 6 (Recycle) to evacuate the refrigerant from the hoses if desired.

```
WEIGHT = XX.X LB
AUTOMATIC? ←
```

▲▲▲▲▲ ENTER

```
WEIGHT = XX.X LB
SETUP? ←
```

ENTER

```
FILTER HOURS =
XX.X HOURS
```

▲

```
TOTAL RECYCLED =
XXXX.X KG
```

▲

```
TOTAL CHARGED =
XXXX.X KG
```

▲

ACCESS STORED DATA

1. Turn the Main Power Switch on.
2. Press the ▲ key five times to display **WEIGHT= XX.X LB SETUP? ←** and then press the ENTER key. The Display will read **FILTER HOURS= XX.X HOURS**.

See Filter Maintenance (Page 15) for the procedure to change the filters. The normal Filter Change Interval is after every 25 hours.

Press and hold the ► key and press the RESET key to remove the **CHANGE FILTERS ←** message.

3. Press the ▲ key. The Display will read **TOTAL RECYCLED XXXX.X KG**.
4. Press the ▲ key. The Display will read **TOTAL CHARGED= XXXX.X KG**.
5. Press the ▲ key to return to the Main Menu.

SET OVER CHARGE AMOUNT

```

WEIGHT =   XX . X  LB
AUTOMATIC?  ←
    
```

▲▲▲▲▲ ENTER

```

WEIGHT =   XX . X  LB
SETUP?    ←
    
```

Press Calibration Switch

```

WEIGHT =   XX . X  LB
CHARGING
    
```

▲

```

OVER CHARGE
AMOUNT =  X . XX  KG ←
    
```

▲▶ENTER

1. Remove two screws on each side to remove front cover. Remove four screws and carefully tilt top control panel up to gain access to printed circuit board cover.

2. Turn the Main Power Switch on.

Refer to the figure below to locate the access hole for the Calibration Switch which is on the underside of the Circuit Board Cover.

3. Remove the plastic Calibration Tool.

4. Press the ▲ key five times to display **WEIGHT= XX.X LB SETUP? ←**.

5. Gently press the Calibration Switch with the Calibration Tool.

The Display will read **WEIGHT= XX.X LB CHARGING**.

6. Press the ▲ key. The Display will read **OVER CHARGE AMOUNT= X.XX KG←**.

7. Press the ▲ key to change the value of the field. Press the ▶ key to move to a different field. The value entered will be stored until this procedure is run again and a new value is entered. Press the ENTER key to accept the value. The Display will then return to the Main Menu.

1 oz = 0.02835 Kg 1 Lb = 0.45359 Kg

8. Place the Calibration Tool in the storage hole.

9. Lower top control panel, being careful to not bend or crimp copper tubes, and install screws. Replace the front cover.

Calibration Tool Part No. 360-81214-00

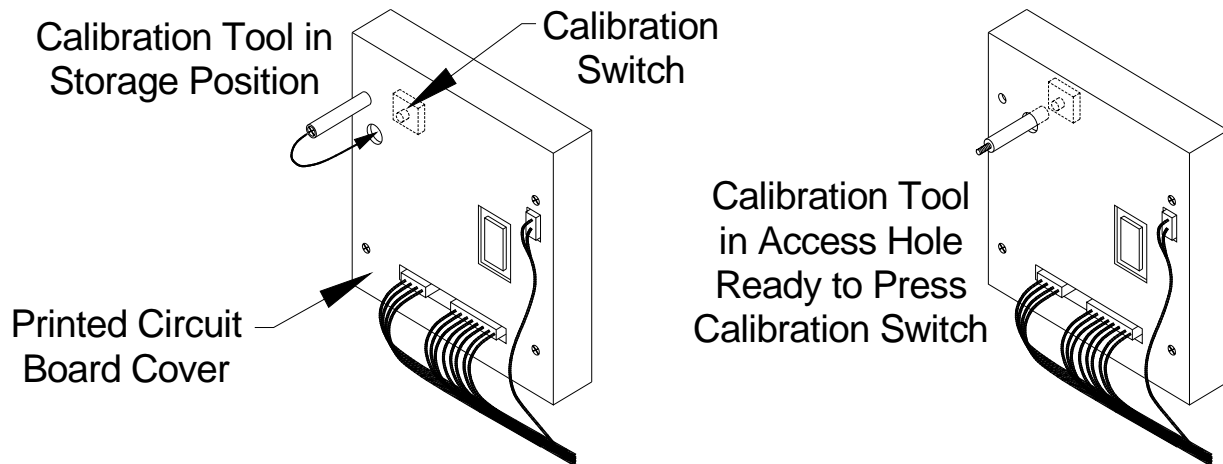

CALIBRATE WEIGHT SCALE

```
WEIGHT = XX.X LB
AUTOMATIC? ←
```

▲▲▲▲▲ ENTER

```
WEIGHT = XX.X LB
SETUP? ←
```

Press Calibration Switch

```
WEIGHT = XX.X LB
CHARGING
```

After 15 minutes or
Press Calibration Switch

```
CALIBRATION
MIN WEIGHT ON ←
```

ENTER

```
CALIBRATION
MAX WEIGHT ON ←
```

ENTER

```
CALIBRATION DONE
REMOVE WEIGHT ←
```

ENTER

```
OVER CHARGE
AMOUNT = X.XX KG ←
```

▲▶ENTER

1. Remove two screws on each side and remove front cover. Remove four screws and carefully tilt top control panel up to gain access to printed circuit board cover. Refer to the illustration on preceding page.
2. Remove Red Hose from High Side Port and **connect the Blue Hose from the High Side Port** to the Vapor Port of a DOT cylinder. Use Low Side Tank Adapter (RTI Part Number 023-80147-00). Open valve on DOT cylinder.
3. Locate the access hole for the Calibration Switch which is on the underside of the Circuit Board Cover.
4. Remove the plastic Calibration Tool.
5. Press the ▲ key five times to display **WEIGHT= XX.X LB SETUP? ←**
6. Gently press the Calibration Switch with the Calibration Tool. The Display will read **WEIGHT= XX.X LB CHARGING**.
The RHS730E charges out the contents of the Charge Cylinder. It automatically continues to the next step after fifteen minutes. The calibration switch can be pressed at any time during this fifteen minutes to proceed to the next step.
7. The Display will read **CALIBRATION MIN WEIGHT ON ←**.
8. Press the ENTER key. The display will read **CALIBRATION MAX WEIGHT ON ←**.
9. Place the two 5 Kg calibration weights on the square plate under the charge cylinder as shown in the illustration below.
10. Press the ENTER key. The display will read **CALIBRATION DONE REMOVE WEIGHT ←**. Remove the Calibration Weights.
11. Press the ENTER key. The display will then read **OVER CHARGE AMOUNT= X.XX KG ←**.
12. Press the ▲ key to change the value of the field. Press the ▶ key to move to a different field. The value entered will be stored until this procedure is run again and a new value is entered. Press the ENTER key to accept the value. The Display will then return to the Main Menu.

1 oz = 0.02835 Kg 1 Lb = 0.45359 Kg

13. Place the Calibration Tool in the storage hole.
14. Lower top control panel, being careful to not bend or crimp copper tubes, and install screws. Replace the front cover and install screws.

Calibration Tool Part No. 360-81214-00

Calibration Weight Kit Part No. 360-81282-00

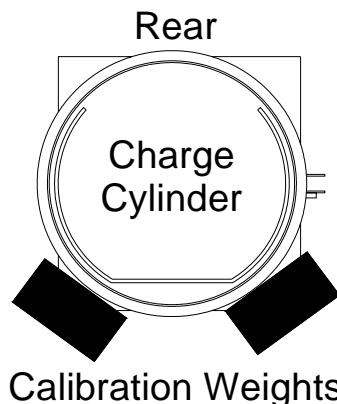

SCHEDULED MAINTENANCE

MONTHLY...

Clean the Condenser to maintain high efficiency performance of the RHS730E. Disconnect power and remove the panel below the filters on the rear of the RHS730E. Blow compressed air through the cooling fins of the Condenser (from inside of cabinet towards the vent slots in the side panel) to remove any debris. Do not bend the fins on the Condenser coils. Air flow will be restricted causing damage to the RHS730E. Replace the panel before applying power to the RHS730E.

FILTER MAINTENANCE

The RHS730E automatically keeps track of Compressor Run Time. The Display will read **CHANGE FILTERS** ← after every 25 hours every time the program returns to the Main Menu or whenever the RHS730E is turned on as a reminder to change the filters. Press ENTER to go to the Main Menu.

The INLET Combo Filter (left side on rear) must be changed after every 25 hours of operation.

RTI part number 026-80069-00.

The OUTLET Combo Filter (right side on rear) must be changed after every 50 hours of operation.

RTI part number 026-80077-00.

The Hours Counter is reset when the **CHANGE FILTERS** ← message is cleared (refer to page 13). Record the filter changes performed to track when only the INLET Combo Filter is changed versus when **both** are changed.

CHANGE FILTERS

1. Disconnect Flare Fittings from top and bottom of filters.
2. Remove mounting nuts and filters.
3. Install new Combo Filters using hardware removed in Step 2.
4. Connect Flare Fittings to top and bottom of filters.
5. Check for leaks and repair as necessary.
6. Go to Page 13, Access Stored Data, for instructions to remove the **CHANGE FILTERS** ← message.

PARTS IDENTIFICATION - Front View

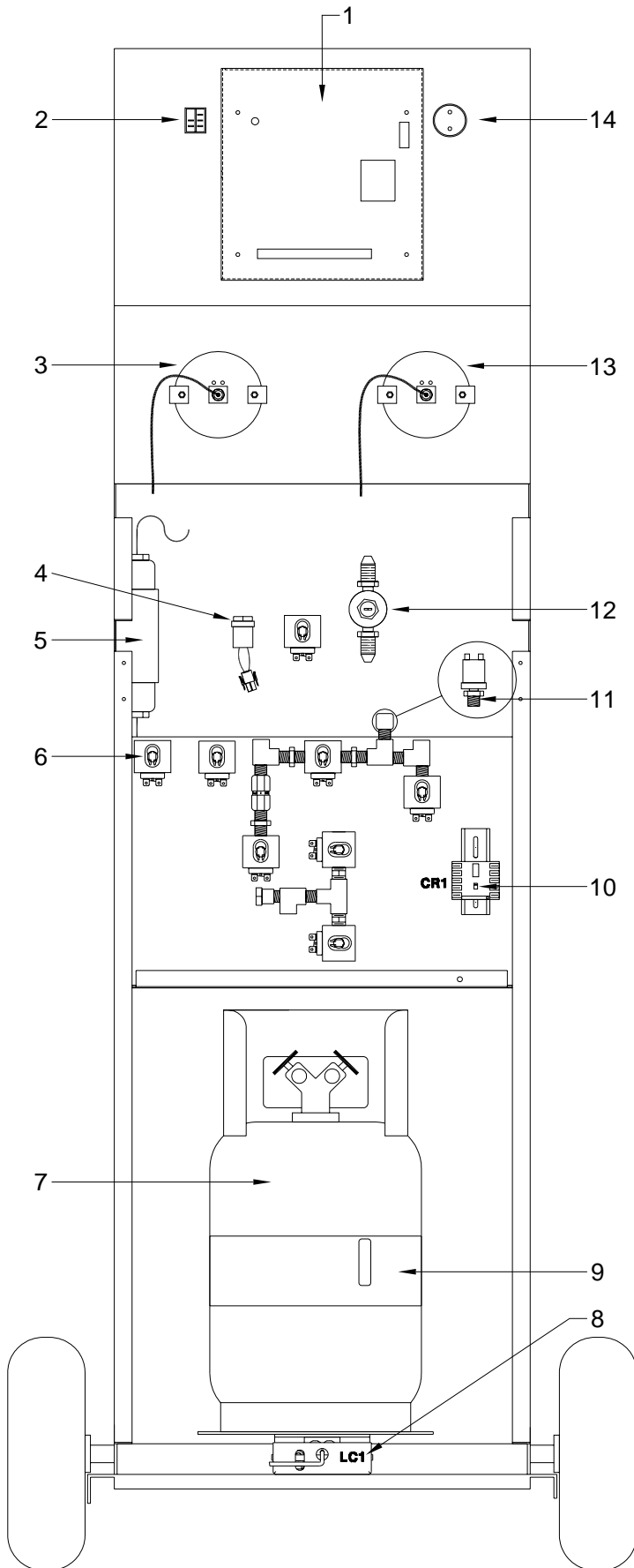

	P/N	DESCRIPTION
1	024-80104-02	Circuit Board 730E 230V
2	024-80040-01	Rocker Switch SPDT (on-on) Amber (250V)
3	026-80065-03	Gauge 30 InHg - 120 PSIG 1/4 MFL 3.5 in.
4	022-80046-01	High Pressure Switch 230V
5	360-80369-02	D/P Switch R134A
6	025-80305-00	Solenoid 230V
7	360-81447-00	DOT Cylinder Assy 30 lbs
8	031-80003-00	Load Cell Assy
9	360-81426-02	Heater Belt Assy
10	024-80037-01	Contactor 1 HP (230V) 3NC - 1NC
11	022-80013-00	Low Pressure Switch 3 PSIG - 8 InHg SPDT
12	022-80110-00	Expansion Valve 3/8 MFL x 3/8 MFL
13	026-80071-03	Gauge 0 - 500 PSIG 1/4 MFL 3.5 in.
14	025-80127-01	Bulb Bayonet Base (230V)
	025-80191-00	Yellow Lens Assy

PARTS IDENTIFICATION - Rear View

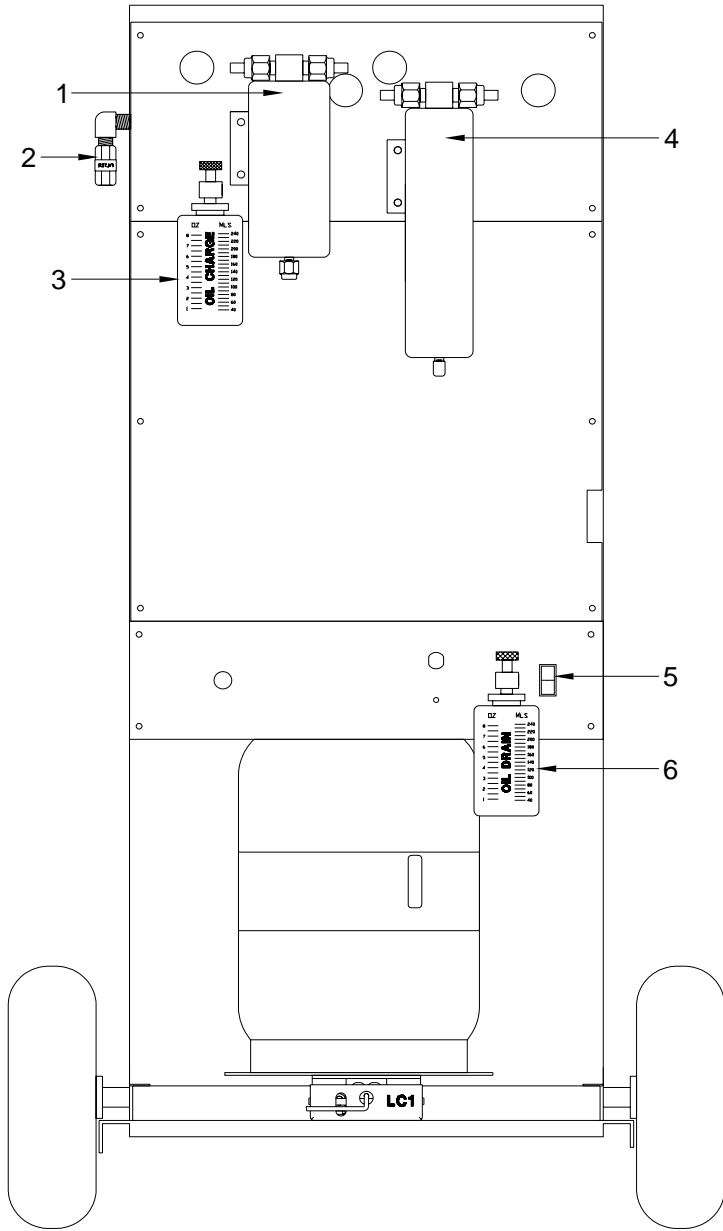

	P/N	DESCRIPTION
1	026-80069-00	Combo Filter 3/8 Flare (Short)
2	026-80240-00	In-Line Hose Filter (R12)
3	026-80208-00	Oil Charge Bottle with Valve
	026-80208-01	Oil Charge Bottle only
4	026-80077-00	Combo Filter 3/8 Flare (Long)
5	024-80035-00	Rocker Switch SPST Momentary On - Non-lighted
6	026-80207-00	Oil Drain Bottle with Valve
	026-80207-01	Oil Drain Bottle only
7	360-81439-00	Condenser Assembly
8	360-80389-00	Fan Assembly
9	360-81700-01	Compressor Assembly 230V
10	026-80070-00	Accumulator Assembly

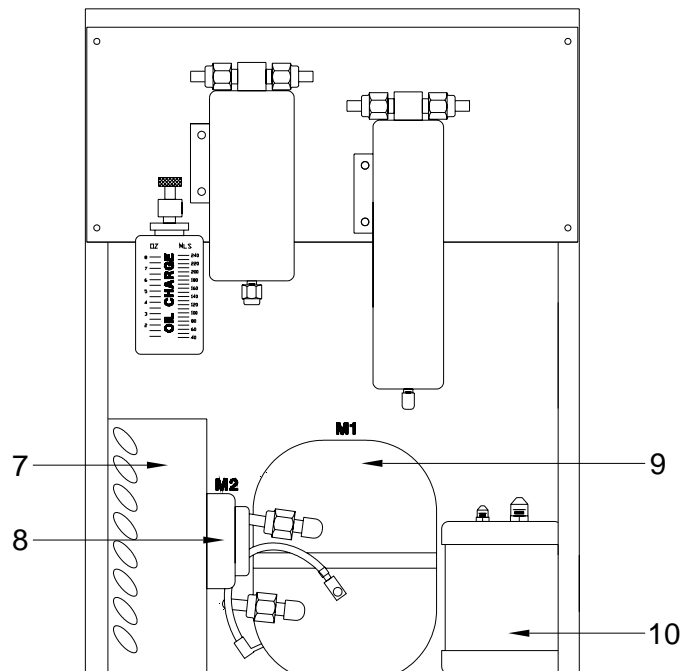

Rear View - Cover Off

Solenoid, Pressure Switch & Contactor Identification

